



# 2m FM TRANSCEIVER

## Model TR-7950 TR-7930



### INSTRUCTION MANUAL

# INTRODUCTION

You are the owner of our latest product, the new TR-7950 (or TR-7930) transceiver. Please read this instruction manual carefully before placing your transceiver in service. The unit has been carefully engineered and manufactured to rigid quality standards, and should give you satisfactory and dependable operation for many years.

## AFTER UNPACKING

- Shipping container:  
Save the boxes and packing in the event your unit needs to be transported for remote operation, maintenance, or service.
- The following explicit definitions apply in this manual:  
**Note:** If disregarded, inconvenience only, no risk of equipment damage or personal injury.  
**Caution:** Equipment damage may occur, but not personal injury.

## CONTENST

ACCESSORIES .....	2
FEATURES .....	3
BEFORE USE .....	4
SPECIFICATIONS .....	5
SECTION 1. INSTALLATION	
1.1 Interconnection .....	6
1.2 Mobile Installation, [general] .....	6
1.3 Fixed Station Installation .....	7
1.4 Memory Back-up Lithium Battery .....	8
SECTION 2. CONTROLS AND TERMINALS	
2.1 Front Panel .....	9
2.2 Rear Panel .....	11
SECTION 3. OPERATION	
3.1 BEFORE OPERATION .....	12
3.2 SQUELCH .....	12
3.3 MEMORY INPUT .....	12
3.4 CHANGING MEMORY FREQUENCIES .....	12
3.5 SCAN OPERATION .....	12
3.6 SCAN STOP .....	13
3.7 SCAN LOCKOUT OPERATION .....	13
3.8 PRIORITY CHANNEL SELECT .....	13
3.9 PRIORITY OPER SWITCH .....	13
3.10 AUTOPATCH OPERATION .....	13
3.11 TIMER OPERATED SCAN .....	13
3.12 AUTOPATCH SIDETONE AND BEEPER LEVEL ADJUSTMENT .....	13
3.13 PAIRED CHANNELS .....	14
3.14 TU-79 (OPTION) INSTALLATION .....	14
SECTION 4. ADDITIONAL INFORMATION .....	15
SECTION 5. OPTIONAL ACCESSORIES .....	16
MEMO .....	17, 18
SCHEMATIC DIAGRAMS .....	19
BLOCK DIAGRAMS .....	20

## ■ ACCESSORIES

Carefully unpack your TR-7950 (or TR-7930) and check that it is supplied with the following accessories:

- (1) Dynamic microphone (with U/D switch)  
(T91-0313-05)..... 1 piece
- (2) Mounting Bracket  
Mounting parts:
  - Hex wrench (w01-0401-04)..... 1 piece
  - Nuts (5 mm diameter)  
(N14-0510-04)..... 4 pieces
  - Hex-socket screw  
(N09-0008-04)..... 4 pieces
  - Flat washers (6 mm diameter)  
(N15-1060-46)..... 4 pieces
  - Spring washer (6 mm diameter)  
(N16-0060-46)..... 4 pieces
- (3) Foot
  - Rubber foot (small, rear)  
(J02-0069-05)..... 2 pieces
  - Rubber foot (large, front)  
(J02-0070-05)..... 2 pieces
  - Screw (N30-3006-41)..... 4 pieces
- (4) DC power cord (with 2P plug and fuse)  
TR-7950(E30-1685-05)/  
TR7930(E30-1674-05)..... 1 piece
- (5) Spare fuse
  - TR-7950(10A) (F05-1031-05)..... 1 piece
  - TR-7930(8A) (F05-8021-05)..... 1 piece
- (7) Miniature plug (for external speaker)  
(E12-0001-15)..... 1 piece
- (9) Warranty card..... 1 copy
- (10) Instruction manual..... 1 copy

# FEATURES

Outstanding features providing maximum ease of operation include a large backlighted, easy-to-read (either in direct sunlight or in the dark) LCD display, 21 multi-function memories, automatic offset, programmable priority channel, memory and programmable band scans, built-in lithium battery memory back-up, built-in 16-key autopatch, and the choice of a hefty 45 watts output (TR-7950), or 25 watts output (TR-7930).

## TR-7950 FEATURES:

- **NEW, large, easy-to-read LCD digital display**

Easy to read in direct sunlight or in the dark (backlighted). Displays transmit/receive frequencies, memory channel, repeater offset, (+, S, -), sub-tone number (F-0, 1, 2, 3), tone scan, and memory scan lock-out. Includes LED S/RF bar meter, and LED indicators for REVERSE, CENTER TUNING, PRIORITY, and ON AIR.

- **21 NEW, multi-function memory channels**

Saves frequency, repeater offset, and optional sub-tone channels. Memories 1 through 15 for simplex for  $\pm 600$  kHz offset. Memory pairs 16/17, and 18/19 are paired for non-standard repeater offset. Memories "A" and "B" set upper and lower scan limits, or for simplex or  $\pm 600$  kHz offset. In MEMORY mode, a circle of light appears around the memory selector knob. When the memory selector knob is rotated in either direction to channel 1, and audible "beep" will sound for visually impaired operators.

- **Choice of 45 or 25 watts output**

The TR-7950 provides a hefty 45 watts output, while the TR-7930 features a more modest 25 watts. A HI/LOW power switch allows power reduction to approx. 5 watts (adjustable).

- **Long-life lithium battery memory back-up**

Built-in lithium battery has an estimated 5 year life.

- **Automatic offset**

The microprocessor is pre-programmed for simplex or  $\pm 600$  kHz offset, in accordance with the ARRL 2 meter band plan. "OS" key allows manual offset change.

- **Programmable priority alert**

The PRIORITY channel may be programmed as any one of the 21 memories, with the ALERT switch "ON," a dual "beep" sounds when a signal is present on the PRIORITY channel. The OPER switch allows and instant move to the PRIORITY channel.

- **Programmable memory scan lock-out**

"LO" key for programming the scan to skip selected memory channels, without erasing the memory.

The lower limit may be programmed into memory "A" and the upper limit into memory "B".

- **Center stop during band-scan, with indicator**

Stops on a channel center during band-scan, with center tuning indicator.

- **Scan resume selectable**

Scan stops on busy channel. Selectable automatic time resume-scan (approx. 5 sec., adjustable), or carrier operated resume-scan. A scan delay after carrier-drop of approx. 1.5 seconds is built-in.

- **Scan control using up/down microphone**

Momentarily pressing UP or DWN button on microphone tunes one step in the selected direction, on memory or on 5-kHz step tuning. Holding the button for about 2 seconds starts UP or DWN automatic scan action. Scan also starts using "SC" key on keyboard. Scan may be cancelled by momentarily pressing the PTT switch or by pressing both UP/DWN buttons simultaneously.

- **Programmable sub-tone channels**

Optional TU-79 three frequency sub-tone unit provides keyboard selectable sub-tone channels, which may be stored in memory.

- **Built-in 16-key autopatch, with adjustable monitor**

The keyboard functions as a 16-key autopatch during transmit. DTMF tones appear in the speaker output when a key is pressed during transmit.

- **Front panel keyboard control**

Used for selecting frequent panel keyboard control. Used for selecting frequency offset, programming memories, controlling scan, and autopatch encode. Keyboard night lighting is provided.

- **Extended frequency coverage**

Covers 142.000-148.995 MHz, in 5-kHz steps.

- **Repeater reverse switch**

Locking-type switch, with indicator.

- **"Beeper" amplified through speaker (Level adjustable)**

- **Compact, lightweight design**

- **Easy-to-install adjustable-angle mobile mounting bracket**

### Optional accessories:

- TU-79 three frequency diode programmable tone unit.
- KPS-12 fixed-station power supply for TR-7950.
- KPS-7A fixed-station power supply for TR-7930.
- SP-40 compact mobile speaker.

# BEFORE USE

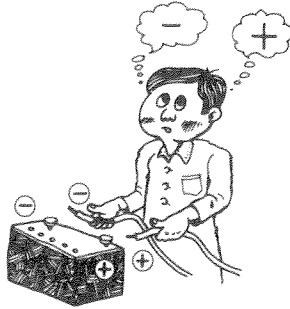

**BEFORE connection, check polarity.**

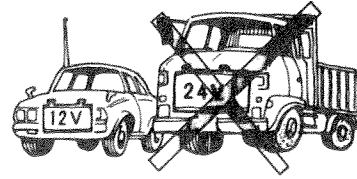

**This unit is designed for 12V negative ground ONLY.**

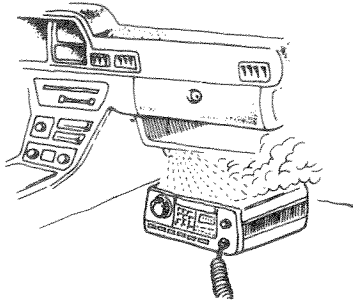

**Do not install near heater outlet.**

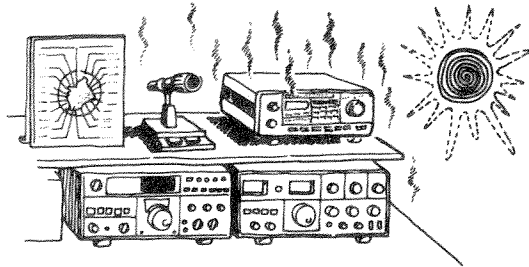

**Keep equipment away from heat and out of direct sunlight.**

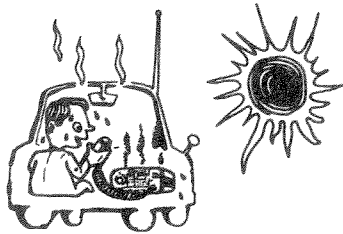

**After parking in the sun, or if inside temperature is HOT, cool this unit BEFORE transmitting.**

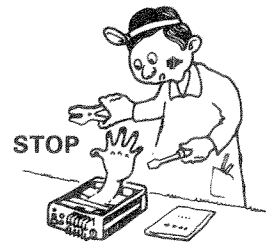

**Do not adjust coil, trimmers, or pots! These are factory adjustments.**

# SPECIFICATIONS

## [General]

<b>Semiconductors</b> .....	MPU	1
	ICs	19
	Transistors	43
	FETs	5
	Diodes	61
<b>Frequency range</b> .....	144.000 to 147.995 MHz	
<b>Frequency synthesizer</b> .....	Digital control, phase locked VCO	
<b>Mode</b> .....	FM (F3)	
<b>Antenna impedance</b> .....	50 ohms	
<b>Power requirement</b> .....	13.8V DC $\pm$ 15%	
<b>Grounding</b> .....	Negative	
<b>Operating temperature</b> .....	-20°C to +50°C	
<b>Current drain</b> .....	0.5V in receive mode with no input signal	
	Max. 9.5A in HI transmit mode (TR-7950)	
	3.0A in LOW transmit mode (TR-7950)	
	Max. 6.5A in HI transmit mode (TR-7930)	
	2.5A in LOW transmit mode (TR-7930)	
<b>Dimension</b> .....	175 mm (6 - 7/8) wide	
	64 mm (2 - 1/2) high	
	220 mm (8 - 11/32") deep (TR-7950)	
	206 mm (8 - 1/16") deep (TR-7930)	
	(projections excluded)	
<b>Weight</b> .....	1.9 kg (4.18 lb) (TR-7950)	
	1.8 kg (3.96 lb) (TR-7930)	

## [Transmitter]

<b>RF output power (at 13.8V DC, 50<math>\Omega</math> load)</b> .....	HI 45 Watts min. (TR-7950)
	HI 25 Watts min. (TR-7930)
	LOW 5 Watts approx. (not adjustable)
<b>Modulation</b> .....	Phase shift
<b>Frequency tolerance (-20°C ~ +50°C)</b> .....	Less than $\pm 15 \times 10^{-6}$
<b>Spurious radiation</b> .....	HI Less than -70 dB
	LOW Less than -60 dB
<b>Maximum frequency deviation (FM)</b> .....	$\pm 5$ kHz
<b>Audio response</b> .....	Within +1/-3 dB of 6 dB/oct pre-emphasis characteristic from 300 to 3000 Hz.
<b>Audio distortion</b> .....	3% max.
<b>Microphone</b> .....	Dynamic microphone with PTT switch, 500 $\Omega$

## [Receiver]

<b>Circuitry</b> .....	Double superheterodyne	
<b>Intermediate frequency</b> .....	1st	10.695 MHz
	2nd	455 kHz
<b>Receiver sensitivity</b> .....	Better than 30 dB for 0.5 $\mu$ V S+N/N	
	Better than 12 dB for 0.25 $\mu$ V SINAD	
<b>Receiver selectivity</b> .....	More than	12 kHz (-6 dB)
	Less than	24 kHz (-60 dB)
<b>Spurious response</b> .....	Better than	70 dB
<b>Squelch sensitivity</b> .....	Less than	0.16 $\mu$ V (threshold)
<b>Auto scan stop level</b> .....	Less than	0.2 $\mu$ V (threshold)
<b>Audio output</b> .....	More than 2.0 watts across 8 ohms load (5% dist.)	

**Note:** Circuit and ratings are subject to change without notice due to developments in technology.

# SECTION 1 INSTALLATION

## 1-1. Interconnection

Connect the antenna and power supply as shown in Fig. 1-1 for fixed station.

## 1-2. MOBILE Installation, [general]

### ● Installation location

Using the supplied mounting bracket, install the transceiver under the dashboard or on the side of the console in your car.

Refer to Fig. 1-2A and Fig. 1-2B on page 7.

If your car is equipped with an electronic fuel injector, the transceiver should be as far from the control equipment as possible.

### ● Antenna installation

Various types of antennas for 2 meter mobile operation are available. (See Fig. 1-2C)

### NOTE:

For gutter-mount installation, the antenna bracket must be grounded to the car body as shown in Fig. 1-2C. Affix the antenna securely, referring to the antenna instruction.

### ● Power supply

Connect the supplied power cable with fuse directly to the battery terminals. Connecting to the cigarette lighter socket can cause a poor connection, and excessive voltage drop.

### ● Ignition noise

The transceiver is designed to suppress ignition noise; however, if excessive noise is present, it may be necessary to use suppressor spark plugs (with resistors).

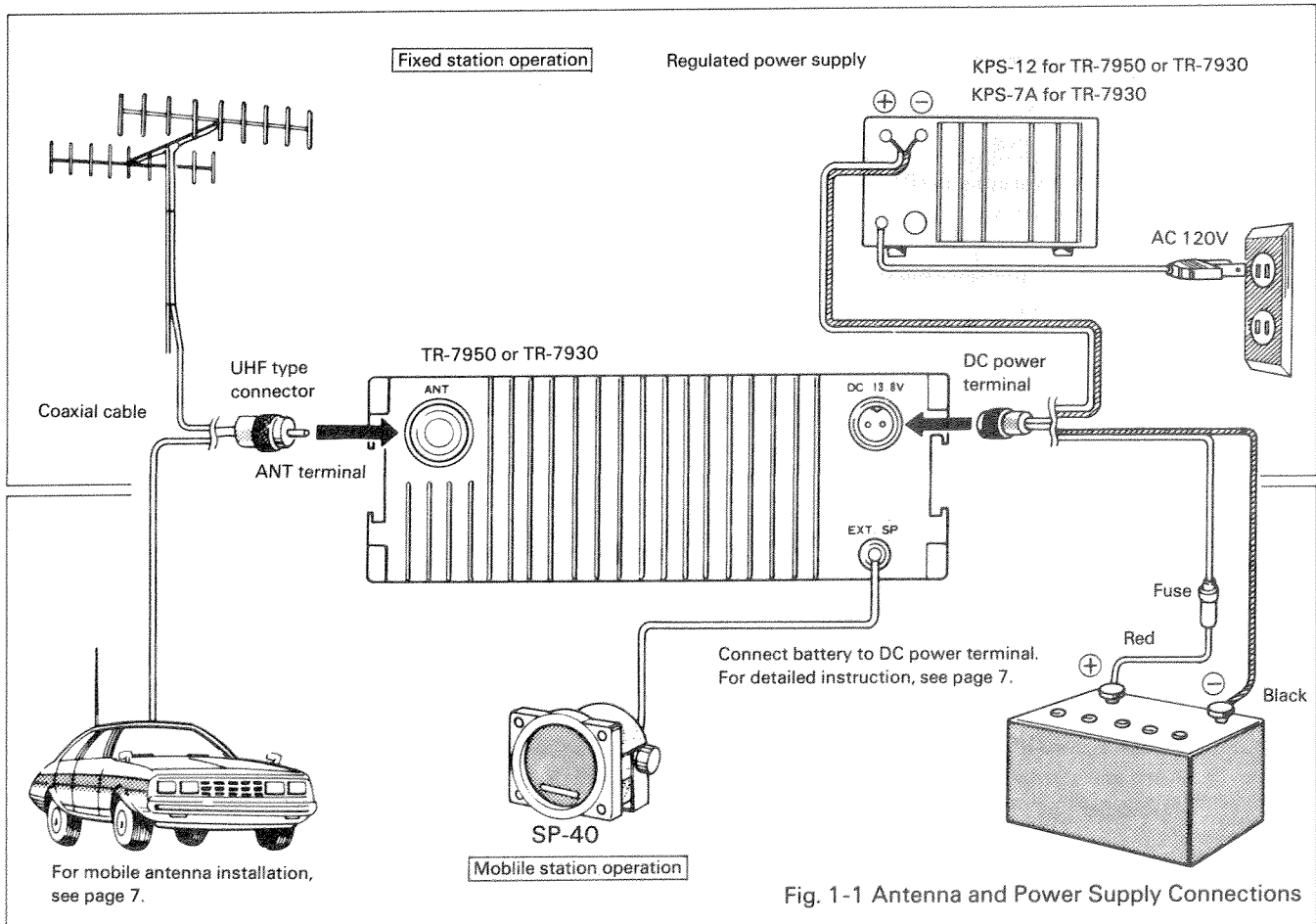

Fig. 1-1 Antenna and Power Supply Connections

### 1-3. FIXED STATION Installation, [general]

● **Power supply (Fig. 1-3 on page 8)**

For the TR-7950, the KPS-12 base power supply is recommended. For the TR-7930, either the KPS-12, or KPS-7A supply is recommended.

● **Antenna (Fig. 1-3 on page 8)**

Various types of fixed station antennas are commercially

available. Select an antenna according to your installation space and application.

Note that the VSWR of your antenna should be less than 1.5:1.

A high VSWR will cause the Transceiver's protective circuit to operate, reducing the transmitter output power.

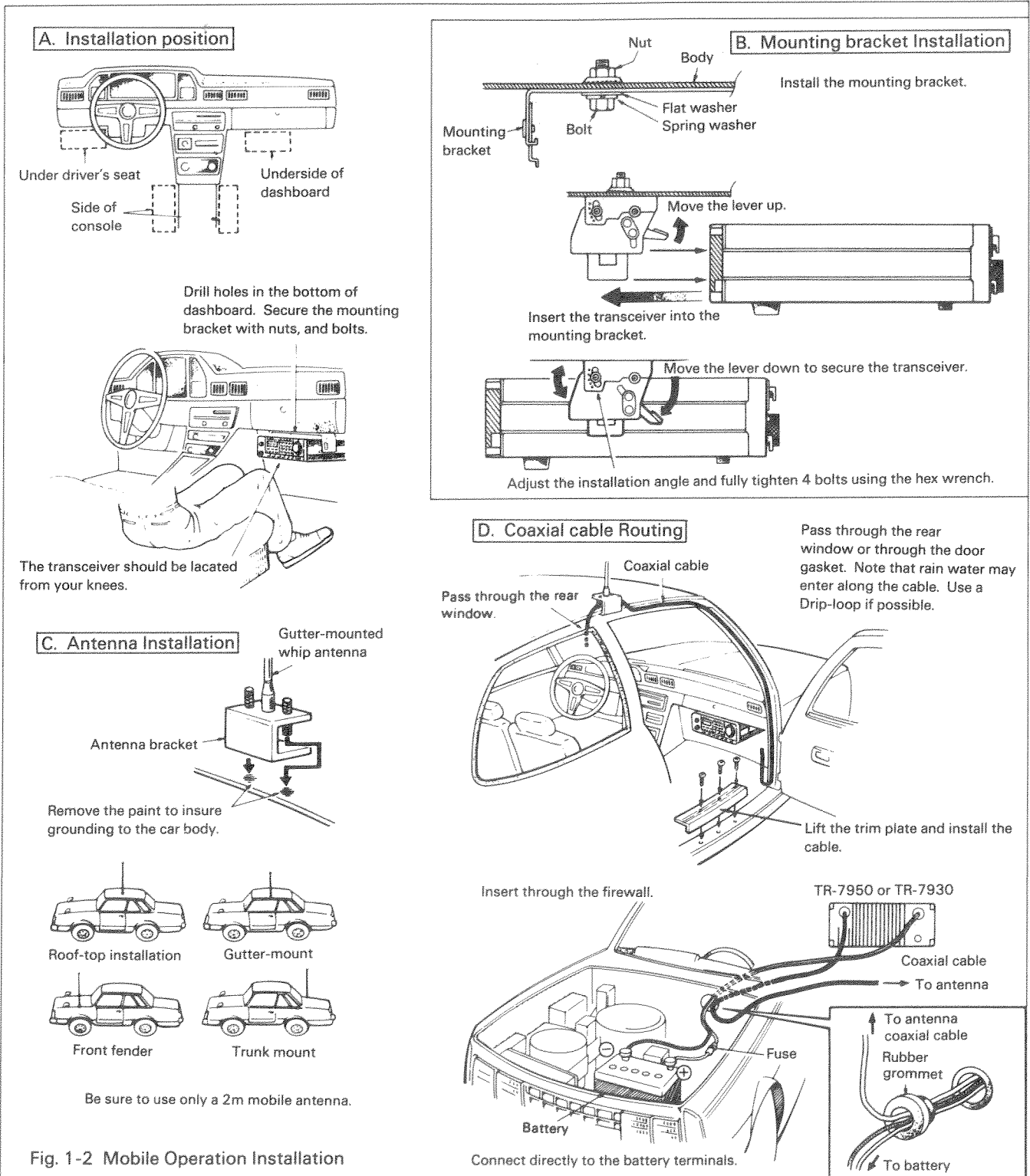
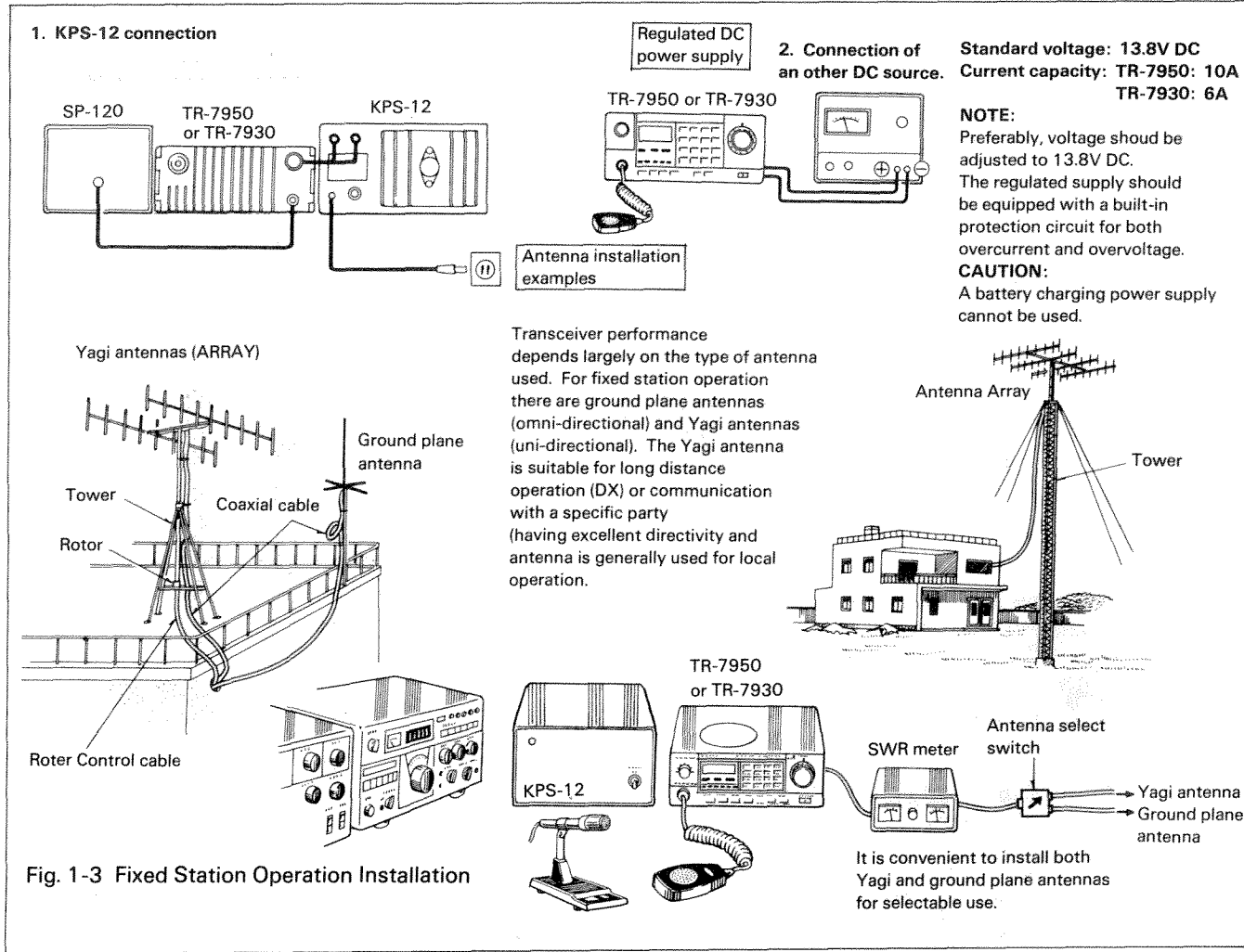

Fig. 1-2 Mobile Operation Installation



**1-4. MEMORY BACK-UP LITHIUM BATTERY**

A lithium battery is contained in the transceiver to retain memory. Therefore, turning off the POWER switch, disconnecting the power cable, or a power failure will not clear the memory. The battery will last approximately five years. When the battery discharges and erroneous display may appear on the LCD. Lithium battery replacement should be performed by an authorized Kenwood service facility – either your Kenwood dealer, or the factory.

**Note:**

When the lithium battery is replaced, the microprocessor must be reset. Press the microswitch accessible through the opening on the bottom cover, as shown.

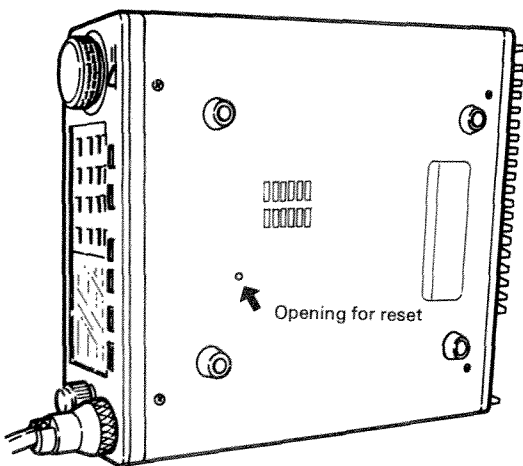

**Fig. 1-4 Microprocessor reset**



# SECTION 2. CONTROLS AND TERMINALS

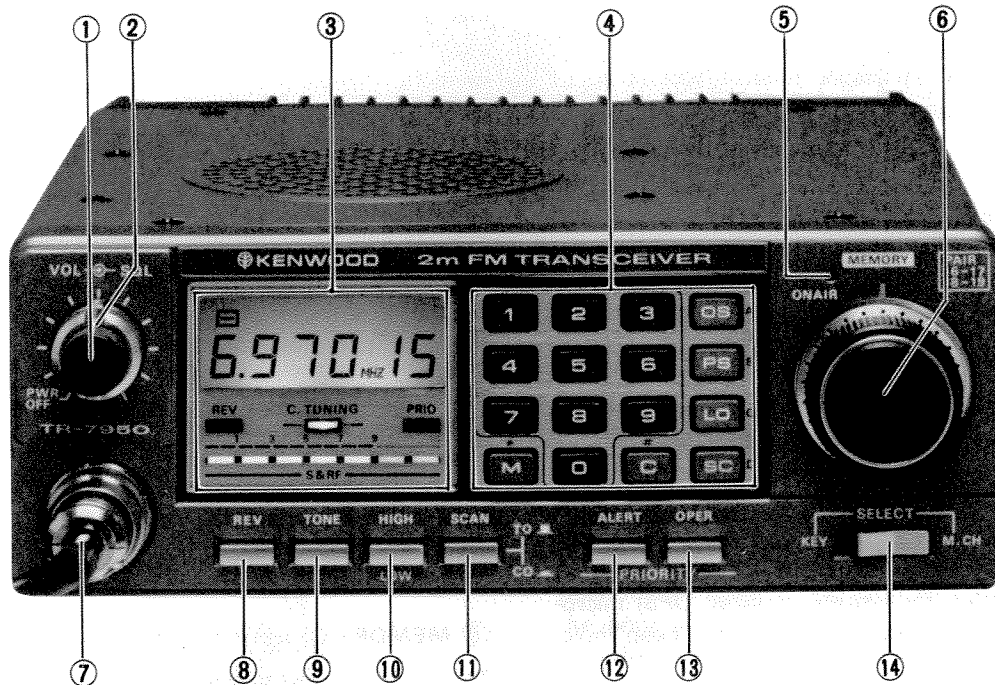

## 2-1. Front Panel

### ① VOL/POWER

Power ON-OFF switch and volume control are combined. Turning the control fully counterclockwise will turn the power OFF. Clockwise rotation will increase the volume.

### ② SQUELCH

The squelch control is used to eliminate noise during no-signal time. Normally, this control is adjusted clockwise until the noise disappears and the Center Tuning indicator goes off (threshold level). For scan operation, this control must be set to the threshold point.

### ③ LCD and Indicator Group

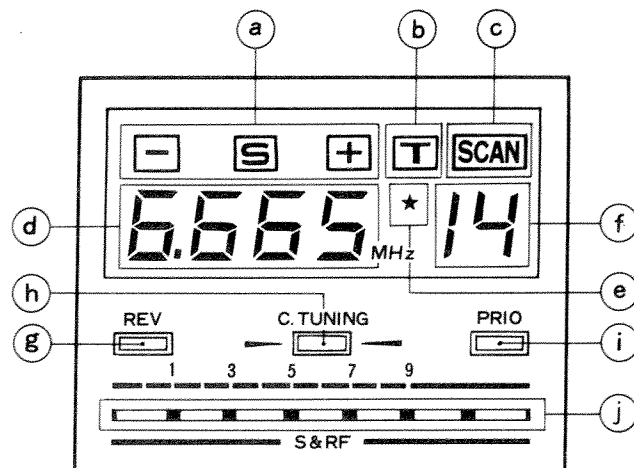

#### a) TX shift indicators:

- ⊖ By pressing the ⊖ key on the keyboard, the ⊖ indicator will light in sequence to show transmit frequency is switched down 600 KHz from the receive frequency.
- S By pressing the S key on the keyboard, the S indicator will light in sequence to show the transceiver is operating in the simplex mode.
- ⊕ By pressing the ⊕ key on the keyboard, the ⊕ indicator will light in sequence to show transmit frequency is switched up 600 KHz from the receive frequency.

#### b) T indicator:

By pressing the TONE pushbutton the four digit frequency display changes to show which of three preset subaudible frequency channels is selected. T does not display at F0 (no tone). TU-79 option required.

c) SCAN indicator lights when scan operation is in progress.

d) This section displays either frequency in four digit (146.520 MHz is displayed as 6.520 ), or one of four subtone conditions (F1 - 3, or 0, no tone).

#### e) ★ mark:

Memory channel scan lock-out designator.

If you desire to skip a busy memory channel during memory scan, press the ☐ key. The star designates scan-skip.

f) Memory channel display indicates A. B. and 1 ~ 19.

- g) This LED indicator lights when the REV switch is ON.
- h) This indicates the transceiver has stopped at channel center.
- i) This LED indicates the PRIORITY-OPER switch ON.
- j) S/RF Level meter  
This LED level meter indicates relative receive input signal strength or transmit RF output.

#### ④ Keyboard

##### "BEEPER" TONE FEEDBACK

Many keys and functions supply user-feedback to assure command entry or execution. Tone level is adjustable. See page 13, "Beeper" level adjustment.

Tone signals:

- \* Keyboard operation frequency entry
- \* Subtone frequency (preset channel number 1 – 3, 0)
- \* Memory \* Clear \* Scan \* Offset
- \* Program scan
- \* Lockout (initiate or cancel)
- \* Tone subtone) on or off

Channel 1 selected by memory channel selector knob (especially convenient for visually impaired OPS) microphone UP or DWN switches; pressonce, one "beep" hold, one "beep" per step or channel.

The keyboard has the following functions (Refer to "SECTION 3. OPERATION"):

##### ● ①–④ (Number) keys:

Depress four keys to set the desired operating frequency.

Example: Depress the ⑥, ⑨, ④ and ④ keys. The frequency display will indicate "6.940" (146.940 MHz).

The number keys function as auto-patch keys during transmit mode (Section 3-6).

Pressing ①, ②, or ③ in the TONE MODE selects the pre-programmed tone frequency. Pressing ④ cancels the selected tone frequency.

##### ● ⑤ (Offset select) key

Depress this key to select a non standard frequency shift (simplex, +, or -, 600 kHz). (Standard frequency shift are preset.)

##### ● ⑥ (Priority Select) key

This is used to designate the priority channel. First, select the desired channel, then depress the PRIORITY-ALERT switch and press the ⑥ switch.

##### ● ⑦ (Lock-out) key

This is used to designate the memory channels to be skipped during memory channel scan. Select the channel to be skipped with the SELECT switch set to M. CH and press this key. A star ★ appears on the LCD to show channel lock-out.

##### ● ⑧ (Scan) key

This is used for scan operation. Press the key when the SQUELCH (2) is ON. This will start band or memory-scan, depending on the position of the SELECT switch.

##### ● ⑨ (M) key

With the SELECT switch in the KEY setting, press this key to store the displayed frequency (with frequency shift) in the selected memory channel. In the TONE MODE and the desired tone frequency selected (①, ②, ③ or ④), pressing this key either stores or clears the TONE designation in memory.

##### ● ⑩ (Clear) key

Use this key if you have mistakenly entered a setting.

By pressing this key, the frequency set by the number keys is cleared. When cleared, the frequency display will indicate the frequency that was displayed before the last entry was cleared.

This key is also used to release the scan operation.

Auto Patch:

This is a 16 button pad in Transmit mode.

During transmission, the key pad is automatically a Tone pad. Simply press any key, as needed.

#### ⑤ ON AIR Indicator

This light emitting diode (L.E.D.) will light during transmit mode.

#### ⑥ MEMORY Channel Selector

This switch is used to select one of 21 memory channels. Of these, channels 1-15 store frequencies including  $\pm 600$  kHz offset. Channels, 16 – 17 and 18 – 19 are paired for "ODD-SPLIT" operation. Channel A stores the programmed scan low frequency limit, and channel B stores the high frequency limit.

#### ⑦ MIC Connector (6-pin)

For connection of the supplied microphone (or and MC-46 autopatch microphone).

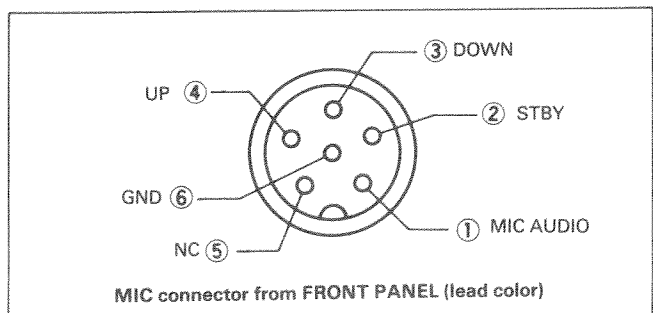

#### ⑧ REV Switch

This switch is used to reverse the repeater shift ( $\pm 600$  kHz) and other transmit/receive frequencies (CH 16 – 17, 18 – 19).

#### ⑨ TONE switch

Press this switch to designate the tone preset frequency channel, along with the ①, ②, or ③ keys. (TU-79 option required for operation.)

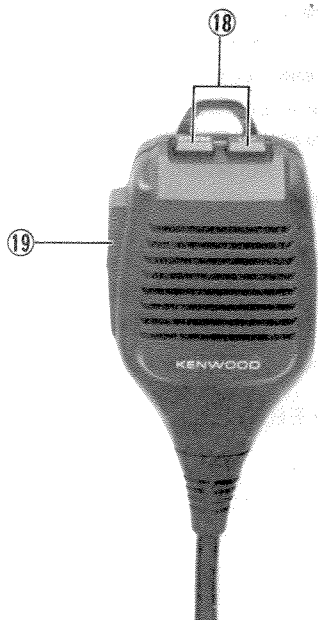
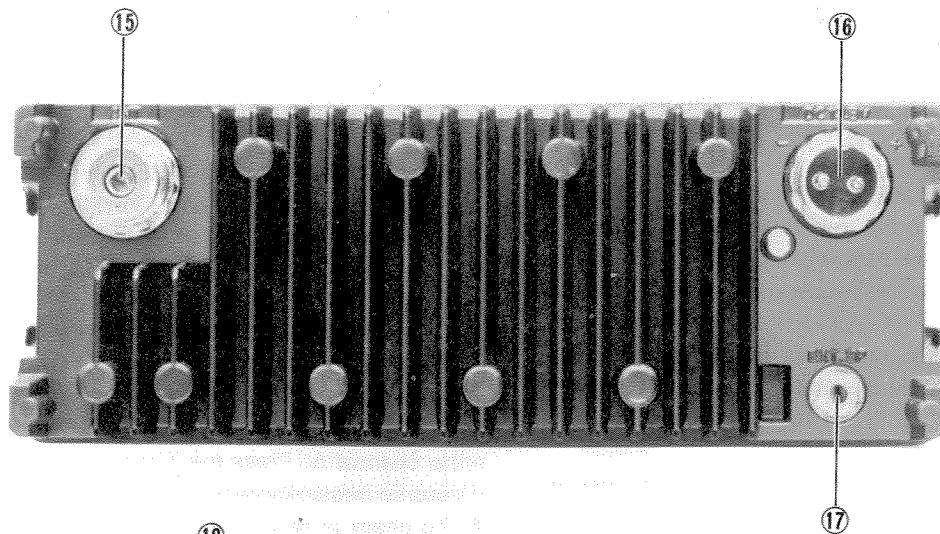

**⑩ HIGH/LOW switch**

**HIGH setting:** This setting allows the TR-7950 to transmit power output up to 45 watts and the TR-7930 up to 25 watts.

**LOW setting:** This setting allows the TR-7950 or TR-7930 to transmit power output up to 5 watts.

**⑪ SCAN switch**

Placing this switch to the TO (timer operation hold) position controls the scan operation by a timer (approximately 5 seconds, adjustable).

Placing this switch to the CO (carrier operated hold) position controls the scan operation by carrier; therefore, scan stops for as long as a carrier is present.

**⑫ PRIORITY ALERT Switch**

This switch is used to check the specified priority channel. Depress the switch and the priority channel will be checked at about a 6 second interval regardless of the KEY/M. CH switch position. A "dual beep" sounds when the priority channel is in use.

**⑬ PRIORITY OPER Switch**

This switch is used to call-up the priority channel. By depressing the switch, operating frequency is switched to the priority channel, and the PRIO LED lights to show operation.

**⑭ SELECT Switch**

Setting this switch to KEY permits keyboard operation; setting to M. CH permits preset memory channel operation.

**2-2 Rear Panel**

**⑮ ANT Terminal**

Connect a 50-ohm antenna to this terminal.

**⑯ DC Power Terminal**

DC power input terminal. Connect the supplied power cord with plug. Input voltage is 13.8V DC. Observe plus(+) and minus(-) polarity!

**⑰ EXT. SP Terminal**

External speaker terminal. Connect a 4 ~ 16 ohm speaker using the supplied plug.

**⑱ UP/DWN Switches**

These switches are used to step the operating frequency up or down during both keyboard and memory channel operation.

When pressing a switch, a tone will sound.

When the UP or DWN switch is held on, scan mode is initiated.

Pressing both the UP and DWN switches simultaneously results in stopping the frequency control operation.

**⑲ PTT Switch**

Press-to-talk switch used for transmission. This will also release scan operation.

# SECTION 3 OPERATION

## 3-1 BEFORE OPERATION

1. This transceiver uses a PLL(phase locked loop) synthesizer controlled by a micro-computer. The operating frequency shifts in 5 kHz steps.
2. The transceiver covers a frequency range of 142.000 to 148.995 MHz.
3. Operating frequencies are input by simple keyboard entry. Up to 21 frequencies may be stored in memory (channels 1 through 19, A and B).
4. Transmitter precautions
  - a) The TR-7950 (or TR-7930) antenna impedance is 50 ohms. Be sure to use only an antenna of 50-ohm impedance.
  - b) Check the intended transmit frequency before operating to prevent interference with other stations.
  - c) Pressing the microphone PTT switch places the transceiver in transmit mode; the ON AIR indicator will light and the LED bar meter shows transmitter power. Recommended distance to the microphone is approximately 5 cm.
5. Should an erroneous or incorrect readout be displayed at first power-on, reset the microprocessor by depressing the reset microswitch, following the instruction on page. 7.
6. Do not press any other keys until the correct frequency is input. The transceiver operates on the last frequency until a new frequency is input.
7. The shift mode is preprogrammed within the amateur band. This, however, can be overridden by the **[S]** key.

f142.0	145.1	145.5	146.0	146.4	146.6	147.0	147.4	147.6	148.0	148.995
S	-	S	+	S	-	+	S	-	S	

8. For frequencies outside the 144.000 – 148.000 MHz, the transceiver operates only in the simplex mode.

## 3-2 SQUELCH

To eliminate receiver noise at the no-signal condition, slowly adjust the squelch clockwise until the noise disappears and the C. TUNING indicator goes off (threshold point).

The squelch will open, the C. TUNING indicator will light and the speaker will operate when a signal is received.

The squelch control is also used for scan operation control. If the signal is weak or fades during mobile operation, readjust the squelch for consistent reception.

## 3-3 MEMORY INPUT

Example: Storing 144.650 MHz with +600 kHz shift and subaudible tone "1" in memory channel 5.

Proceed:

1. Set the SELECT switch to KEY.
2. Press the **[4]**, **[6]**, **[5]**, and **[0]** keys.
3. Press the **[S]** key until **[+]** displays on the LCD.
4. Turn the MEMORY channel selector until memory 5 displays.
5. Press the **[M]** key to store in memory channel 5.
6. Press the TONE switch and select the desired tone frequency; in this case, by pressing the **[1]** key.
7. Again press the **[M]** key to store the TONE information in channel 5. Press the TONE switch again to call the stored frequency back to the display.
8. To check or recall the entry in channel 5, place the SELECT switch to M. CH. Display should remain unchanged, indicator data is correctly stored.
9. Use this general procedure to store frequencies in the other memory channels.

## 3-4 CHANGING MEMORY FREQUENCIES

If you wish to change any memory frequency, store a new frequency in that channel using the previous procedure. The old frequency is erased when the new frequency is stored.

## 3-5 SCAN OPERATION

The SCAN operation is divided into keyboard scan, memory scan and priority channel scan. For SCAN operation, the squelch control should be advanced to the threshold point. See section 3-2 Squelch.

First, select either timer operated hold (TO) carrier (signal) operated hold (CO) with the SCAN switch.

### ● MEMORY SCAN from the keyboard

1. Set the SELECT switch to M. CH.
2. Press the **[S]** key to initiate scanning.

The scan will begin from the displayed channel advancing, toward the higher numbered channels. During this operation, holding the microphone DWN switch changes scan direction backward. Releasing the DWN switch returns scan direction forward. Holding the UP switch permits accelerated scanning.

3. To release the scan operation, press either the **[C]** key, the microphone PTT switch, or the microphone UP and DWN switches simultaneously.

### ● MEMORY SCAN from the microphone

1. Set the SELECT switch to M. CH.
2. Hold the UP (or DWN) switch for more than one second and scan operation will commence UP (or DWN) from the displayed channel. During this scan operation, pressing the DWN (or UP) switch once reverses the scan direction.

3. To manually accelerate scanning, hold the UP (or DWN) switch until the desired memory channel is reached.

4. To release the scan operation, press the PTT switch or the UP and DWN switches simultaneously.

#### ● PROGRAMMABLE BAND-SCAN from the keyboard

The lower limit may be programmed into memory "A", and the upper limit in to memory "B".

1. Set the SELECT switch to KEY.

2. Press the  key to initiate scan operation.

Scan will start from the frequency stored in memory channel A and advance to the frequency stored in channel B. When the frequency in memory channel B is reached the process. During this operation, holding the microphone DWN switch changes the scan direction backward. When the DWN switch is released, the forward scan direction resumes. Holding the UP switch accelerates scanning.

3. To release the scan operation, press the  key, the microphone PTT switch, or the microphone UP and DOWN switches simultaneously.

4. To continue an interrupted keyboard scan from its stopping-point, use the microphone UP or DWN switches. Otherwise, the  key will always return the radio to the A channel frequency.

#### ● AUTO SCAN from the microphone

1. Set the SELECT switch to KEY.

2. Hold the UP (or DWN) switch for more than one second. Scan operation will commence from the frequency displayed towards the upper frequency limit (148.995 MHz) or if down, towards the lower limit (142.000 MHz).

During this scan, press the DWN (or UP) switch reverses the scan direction.

3. To accelerate the scan, hold the UP (or DWN) switch until the desired frequency is reached.

4. To release the scan operation, press the PTT switch or the UP and DWN switches simultaneously.

#### ● PRIORITY CHANNEL SCAN

To monitor the priority channel, press the PRIORITY-ALERT switch in. When it is busy two beeps will sound every six seconds. The REV switch deactivates this system.

### 3-6 SCAN STOP

1. Scan may be cancelled by turning off the power switch or power supply.

2. Transmitting or momentarily keying the PTT switch.

3. Pressing the keyboard  key.

4. Pressing the microphone UP and DWN switches simultaneously.

5. Pressing the REV switch.

6. Pressing the PRIORITY ALERT switch.

7. Pressing the PRIORITY OPER switch.

8. Moving the SELECT switch to the alternate mode.

### 3-7 SCAN LOCKOUT OPERATION

This transceiver has a scan lockout function which allows selectively skipping temporarily unwanted memory channels during memory scan.

Proceed:

1. Place the SELECT switch to M. CH.

2. Select the memory channel to be skipped by using the MEMORY selector.

3. Press the  key and a star ★ appears to the left of the memory channel number.

4. Perform steps 2 and 3 to lockout any unwanted memory channels.

To cancel channel lockout, select the memory channel to be restored, and press the  key. The star will disappear.

### 3-8 PRIORITY CHANNEL SELECT

Any one of the 21 memory channels can be selected as the priority channel.

1. Set the SELECT switch to M. CH.

2. Press the PRIORITY-ALERT switch in.

3. Select the memory to be the priority channel.

4. Press the  key to enter this instruction.

### 3-9 PRIORITY OPER Switch

To call-up the frequency stored in the priority channel, depress the PRIORITY OPER switch.

### 3-10 AUTOPATCH OPERATION

Press any key on the keyboard in transmit mode for autopatch operation.

### 3-11 TIMER OPERATED SCAN (TO) ADJUSTMENT

The scan timer is factory preset at approximately 5 seconds. This can be adjusted from 2 to 6 seconds.

1. Place the SCAN switch to TO.

2. Turn the SQL control fully counterclockwise to open the squelch.

3. Place the SELECT switch to M. CH.

4. Initiate scan by pressing the  key.

5. Adjust VR1 (X53-1280-10) to the desired delay. (see Bottom Biew on page 14.)

### 3-12 AUTOPATCH SIDETONE AND BEEPER LEVEL ADJUSTMENT

The autopatch sidetone level during and beeper level transmit are adjustable. As the volume is advanced, the level increases.

1. Adjust the VOL control to your normal listening level.

2. With the microphone PTT press any key on the keyboard switch depressed and adjust VR3 (X55-1330-10) shown on page 14.

### 3-13 PAIRED CHANNELS

Two paired channels allow for "odd split" frequency shifts. Use this option when the desired frequency shift is to other than the standard 600 kHz shift. Any split within the full operating and range of the radio is possible.

Channel pairs are: CH's 16 – 17 and CH's 18 – 19

Example: A 1 MHz split store 145.600 MHz in CH 16 and 146.600 MHz in CH 17.

1. Follow the "MEMORY INPUT" procedure on page 12 to store these frequencies in channels 16 and 17. Either frequency (receive or transmit) may be stored in either channel of the pair.

2. To operate this channels pair, set the SELECT switch to M. CH and select either CH 16 with the MEMORY selector.

3. Transmit, and the displayed frequency changes to the transmit frequency stored in the alternate channel of the pair.

4. Return to the receive mode, and the original receive frequency stored in CH 16 will display.

The other channel pair, CH 18 – 19, operates in the same way. When channel pairs are used, the 600 kHz shift and-mode indicators,  $\oplus$ ,  $\ominus$ , and  $\odot$ , do not function.

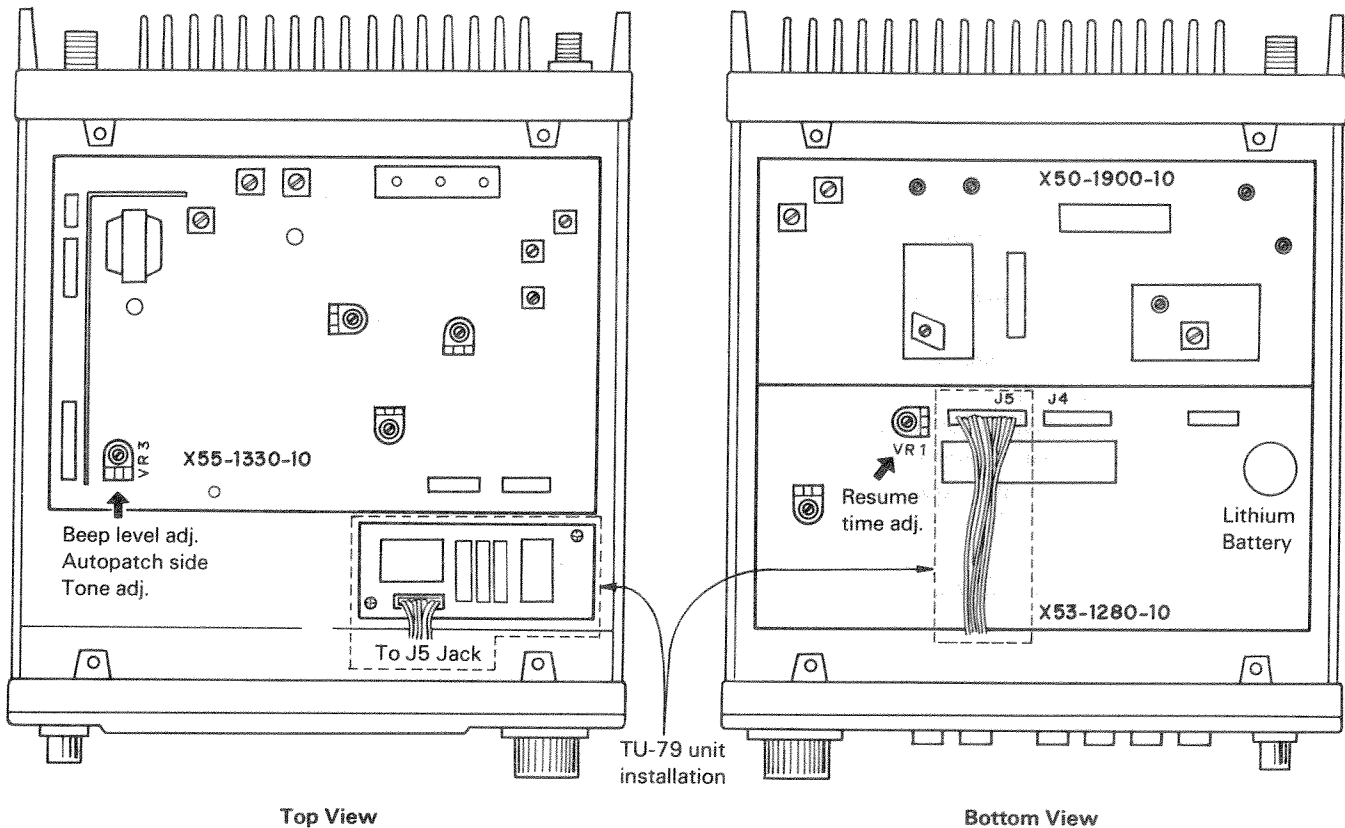

Top View

Bottom View

### 3-14 TU-79 (OPTION) INSTALLATION

1. Secure the TU-79 unit with 2 screws as shown in figure (Top View, within dotted line).
2. Plug the TU-79 lead connector to the jack (J5) shown in the figure (Bottom View).
3. Three tone frequencies can be selected out of 37 frequencies (67 Hz ~ 250.3 Hz). This can be done by 6 bit diode matrix.
4. Tone deviation is within  $\pm 0.5 \sim 0.7$  kHz, adjusted.

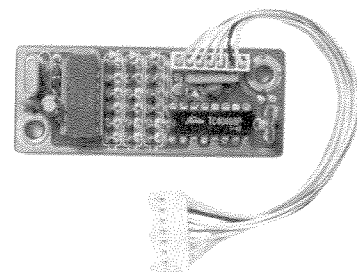

TU-79

## SECTION 4 ADDITIONAL INFORMATION

### 4-1 General Information

Your TR-7950 (or TR-7930) has been factory aligned and tested to specification before shipment. Under normal circumstances, the transceiver will operate in accordance with these operating instructions.

If your transceiver fails to work, contact the authorized dealer from which you purchased it for quick, reliable repair. All adjustable trimmers and coils in your transceiver were preset at the factory and should only be readjusted by a qualified technician with proper test equipment.

Attempting service or alignment without factory authorization is not recommended.

### 4-2 How the TX Final Module are Protected

Final module protection is provided by sampling the reflected power. As the reflected power is increased (higher SWR) transmitter drive is reduced, thus decreasing input to the final module. This in turn reduces collector loss, protecting the final transistor.

### 4-3 Battery Precaution

When charging your vehicle battery, or when jump-starting a dead battery, ALWAYS disconnect the power cable from the back of the transceiver.

### 4-4 Ordering Spare Parts

When ordering replacement or spare parts for your equipment, be sure to specify the following:

- Model and serial number of your transceiver. Schematic number of the part. Printed circuit board number on which the part is located. Part number and name, if known, and quantity desired.

**NOTE:** \_\_\_\_\_

A full service manual is available as a separate publication.

### 4-5 Service

Should it ever become necessary to return the equipment for repair, pack in its original box and packing, and include a full description of the problems involved. Also include your telephone number. You need not return accessory items unless directly related to the service problem. Tag all returned items with your call for identification.

Please mention the model and serial number of your radio in any correspondence, whether phone or written. For future reference, record this information in the space provided on the back cover of this manual.

**NOTE:** \_\_\_\_\_

When claiming warranty service, please include a photocopy of the bill of sale, or other proof of purchase showing the date of sale.

## SECTION 5. OPTIONAL ACCESSORIES

The following accessories are available for more sophisticated operation of your transceiver.

### 5-1 Fixed Station DC Power Supply KPS-12A

The KPS-12 DC power supply matches both the TR-7950 and TR-7930 while the KPS-7A matches the TR-7930.

### 5-2 SP-40 External Speaker

Designed primarily for mobile operation. Styling and tone quality match your transceiver.

### 5-3 TU-79 Tone Unit

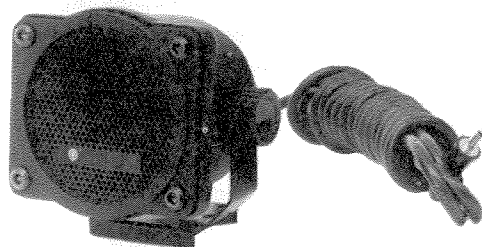

SP-40



**MEMO**

.....

.....

.....

.....

.....

.....

.....

.....

.....

.....

.....

.....

.....

.....

.....

.....

.....

.....

.....

.....

.....

.....

.....

.....

.....